



ANTI URTO
ANTI SHOCK



5m



120°



IP69K



MICROPHONE

T3

TELECAMERA CMOS A COLORI

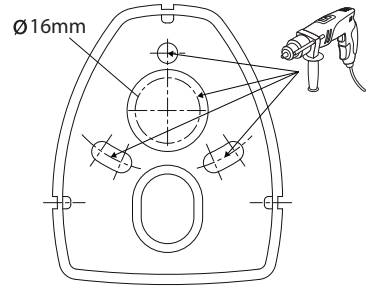

ATTENZIONE

- Installare la videocamera in una posizione sicura e stabile
- Non installare la videocamera sul paraurti posteriore o più in basso così da evitare di creare angoli ciechi.
- Evitare di installare la videocamera in posizioni dove la lente può sporcarsi facilmente con fango, polvere, fumi di scarico, ecc...
- Assicurarsi di sigillare i fori fatti per installare la telecamere così da impedire il passaggio dell'acqua.

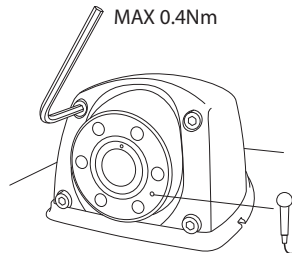
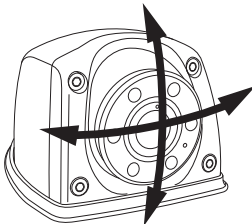
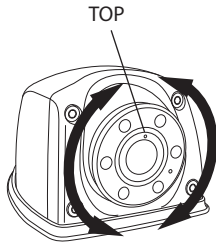
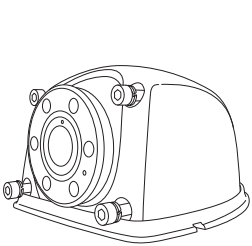
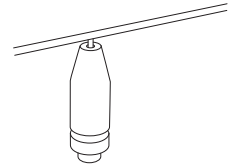
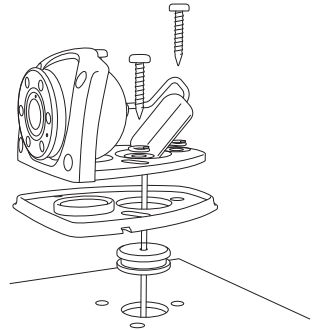



EN T3 CMOS COLOUR VIDEO CAMERA

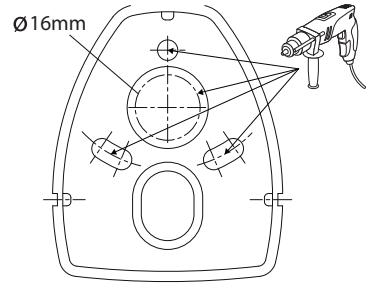

WARNING

- Install the camera on a safe and stable surface
- Avoid installing the camera on the rear bumper or in a lower position, so that there won't be any blind spots.
- Avoid installing the camera in places where the lens can easily get dirty from mud, exhaust gases, etc...
- Be sure to seal the holes made during the installation of the camera to avoid water to flow inside.

